

Power Drivers for Peltier TEC Modules

General Description

The MAX1968/MAX1969 are highly integrated and cost-effective, high-efficiency, switch-mode drivers for Peltier thermoelectric cooler (TEC) modules. Both devices utilize direct current control to eliminate current surges in the TEC. On-chip FETs minimize external components while providing high efficiency. A 500kHz/1MHz switching frequency and a unique ripple cancellation scheme reduce component size and noise.

The MAX1968 operates from a single supply and provides bipolar $\pm 3A$ output by biasing the TEC between the outputs of two synchronous buck regulators. Bipolar operation allows for temperature control without “dead zones” or other nonlinearities at low load currents. This arrangement ensures that the control system does not hunt when the set point is very close to the natural operating point, requiring a small amount of heating or cooling. An analog control signal precisely sets the TEC current. The MAX1969 provides unipolar output up to 6A. Reliability is optimized with settable limits for both TEC voltage and current, with independently set limits for heating and cooling current. An analog output also monitors TEC current.

The MAX1968/MAX1969 are available in a low-profile 28-pin TSSOP-EP package and is specified over the $-40^{\circ}C$ to $+85^{\circ}C$ temperature range. The thermally-enhanced TSSOP-EP package with exposed metal pad minimizes operating junction temperature. An evaluation kit is available to speed designs.

Applications

Fiber Optic Laser Modules
WDM, DWDM Laser Diode Temperature Control
Fiber Optic Network Equipment
EDFA Optical Amplifiers
Telecom Fiber Interfaces
ATE
Biotech Lab Equipment

Pin Configuration and Functional Diagram appear at end of datasheet.

Features

- ◆ Direct Current Control Prevents TEC Current Surges
- ◆ On-Chip Power MOSFETs
- ◆ High-Efficiency Switch-Mode Design
- ◆ Ripple Cancellation for Low Noise
- ◆ No Dead-Zone or Hunting at Low-Output Current
- ◆ Adjustable TEC Voltage Limit
- ◆ Separately Adjustable Heating and Cooling Current Limits
- ◆ ITEC Output Monitors TEC Current
- ◆ 1% Accurate Voltage Reference
- ◆ 500kHz/1MHz Switching Frequency
- ◆ $\pm 3A$ Output Current (MAX1968)
- ◆ 6A Output Current (MAX1969)
- ◆ Thermally Enhanced TSSOP-EP Package

Ordering Information

PART	TEMP RANGE	PIN-PACKAGE
MAX1968EUI	$-40^{\circ}C$ to $+85^{\circ}C$	28 TSSOP-EP*
MAX1969EUI	$-40^{\circ}C$ to $+85^{\circ}C$	28 TSSOP-EP*

*EP = exposed paddle

Typical Operating Circuit

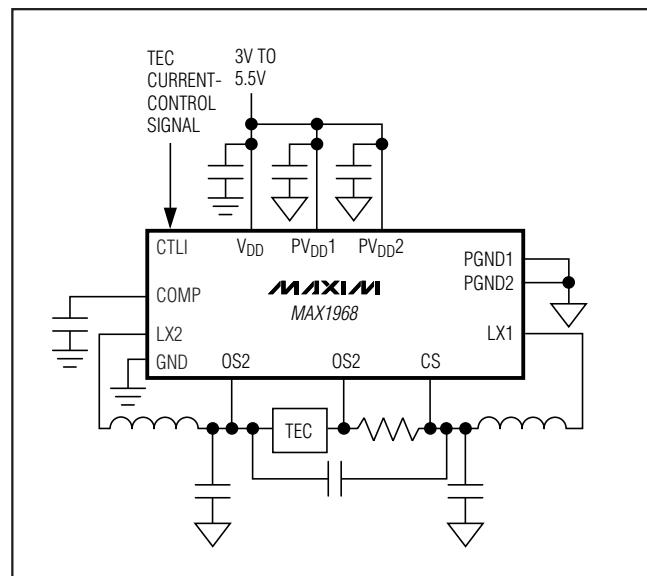

Power Drivers for Peltier TEC Modules

ABSOLUTE MAXIMUM RATINGS

V _{DD} to GND	-0.3V to +6V
SHDN, MAXV, MAXIP, MAXIN, CTLI, FREQ to GND	-0.3V to +6V
COMP, OS1, OS2, CS, REF, ITEC to GND	-0.3V to (V _{DD} + 0.3V)
PV _{DD1} , PV _{DD2} to GND	-0.3V to (V _{DD} + 0.3V)
PV _{DD1} , PV _{DD2} to V _{DD}	-0.3V to +0.3V
PGND1, PGND2 to GND	-0.3V to +0.3V
COMP, REF, ITEC Short to GND	Indefinite

Peak LX Current (MAX1968) (Note 1)	±4.5A
Peak LX Current (MAX1969) (Note 1)	+9A
Continuous Power Dissipation (T _A = +70°C)	28-Pin TSSOP-EP (derate 23.8mW/°C above +70°C)..... 1.9W
Operating Temperature Range	-40°C to +85°C
Maximum Junction Temperature	+150°C
Storage Temperature Range	-65°C to +150°C
Lead Temperature (soldering 10s)	+300°C

Note 1: LX has internal clamp diodes to PGND and PV_{DD}. Applications that forward bias these diodes should take care not to exceed the IC's package power dissipation limits.

Stresses beyond those listed under "Absolute Maximum Ratings" may cause permanent damage to the device. These are stress ratings only, and functional operation of the device at these or any other conditions beyond those indicated in the operational sections of the specifications is not implied. Exposure to absolute maximum rating conditions for extended periods may affect device reliability.

ELECTRICAL CHARACTERISTICS

(V_{DD} = PV_{DD1} = PV_{DD2} = $\overline{\text{SHDN}}$ = 5V, PGND1 = PGND2 = FREQ = GND, CTLI = MAXV = MAXIP = MAXIN = REF, C_{REF} = 1μF, C_{COMP} = 0.1μF, L_{LX} = 3.3μH, C_{CS} = C_{OS2} = 1μF, I_{TEC} < 3A_{RM}S (MAX1968), I_{TEC} < 6A_{RM}S (MAX1969), T_A = 0°C to +85°C, unless otherwise noted. Typical values are at T_A = +25°C.)

PARAMETER	SYMBOL	CONDITIONS	MIN	TYP	MAX	UNITS	
Input Supply Range	V _{DD}		3.0		5.5	V	
Output Voltage Range	V _{OUT}	V _{DD} = 5V, I _{TEC} = 0 to ±3A, V _{OUT} = V _{OS1} - V _{OS2} (MAX1968)	-4.3		+4.3	V	
		V _{DD} = 5V, I _{TEC} = 0 to 6A, V _{OUT} = V _{OS1} (MAX1969)			4.3		
		V _{DD} = 3V, I _{TEC} = 0 to ±3A, V _{OUT} = V _{OS1} - V _{OS2} (MAX1968)	-2.3		+2.3		
		V _{DD} = 3V, I _{TEC} = 0 to 6A, V _{OUT} = V _{OS1} (MAX1969)			2.3		
Maximum TEC Current	I _{TEC(MAX)}	MAX1968			±3	A	
		MAX1969			6		
Reference Voltage	V _{REF}	V _{DD} = 3V to 5.5V, I _{REF} = 150μA	1.485	1.500	1.515	V	
Reference Load Regulation	ΔV _{REF}	V _{DD} = 3V to 5.5V, I _{REF} = +10μA to -1mA		1.2	5	mV	
Current-Sense Threshold Accuracy		V _{OS1} < V _{CS}	V _{MAXI} = V _{REF}	140	150	160	mV
			V _{MAXI} = V _{REF} /3	40	50	60	
		V _{OS1} > V _{CS}	V _{MAXI} = V _{REF}	140	150	160	
			V _{MAXI} = V _{REF} /3	40	50	60	
Switch-Fault Reset Voltage			50	150	250	mV	
NFET On-Resistance	R _{DS(ON-N)}	V _{DD} = 5V, I = 0.5A		0.04	0.07	Ω	
		V _{DD} = 3V, I = 0.5A		0.06	0.08		
PFET On-Resistance	R _{DS(ON-P)}	V _{DD} = 5V, I = 0.5A		0.06	0.10	Ω	
		V _{DD} = 3V, I = 0.5A		0.09	0.12		
NFET Leakage	I _{LEAK(N)}	V _{LX} = V _{DD} = 5V, T _A = +25°C		0.02	10	μA	
		V _{LX} = V _{DD} = 5V, T _A = +85°C		1			

Power Drivers for Peltier TEC Modules

MAX1968/MAX1969

ELECTRICAL CHARACTERISTICS (continued)

(V_{DD} = PV_{DD1} = PV_{DD2} = $\overline{\text{SHDN}}$ = 5V, PGND1 = PGND2 = FREQ = GND, CT_{LI} = MAXV = MAXIP = MAXIN = REF, C_{REF} = 1 μ F, C_{COMP} = 0.01 μ F, L_{LX} = 3.3 μ H, C_{CS} = C_{OS2} = 1 μ F, I_{TEC} < 3A_{RMS} (MAX1968), I_{TEC} < 6A_{RMS} (MAX1969), T_A = 0°C to +85°C, unless otherwise noted. Typical values are at T_A = +25°C.)

PARAMETER	SYMBOL	CONDITIONS	MIN	TYP	MAX	UNITS
PFET Leakage	I _{LEAK(P)}	V _{LX} = 0, T _A = +25°C		0.02	10	μ A
		V _{LX} = 0, T _A = +85°C		1		
No Load Supply Current	I _{DD} (NO LOAD)	V _{DD} = 5V		32	100	mA
		V _{DD} = 3.3V		20	30	
Shutdown Supply Current	I _{DD-SD}	V _{DD} = 5V (Note 2)		2	3	mA
Thermal Shutdown	T _{SHUTDOWN}	Hysteresis = 15°C		+165		°C
UVLO Threshold	V _{UVLO}	V _{DD} rising	2.4	2.6	2.8	V
		V _{DD} falling	2.25	2.5	2.75	
Switching Frequency Internal Oscillator	f _{SW-INT}	FREQ = GND	400	550	650	kHz
OS1, OS2, CS Input Current	I _{OS1} , I _{OS2} , I _{CS}	0 or V _{DD}	-100		+100	μ A
$\overline{\text{SHDN}}$, FREQ Input Current	I _{SHDN} , I _{FREQ}	0 or V _{DD}	-5		+5	μ A
$\overline{\text{SHDN}}$, FREQ Input Low Voltage	V _{IL}	V _{DD} = 3V to 5.5V			V _{DD} x 0.25	V
$\overline{\text{SHDN}}$, FREQ Input High Voltage	V _{IH}	V _{DD} = 3V to 5.5V	V _{DD} x 0.75			V
MAXV Threshold Accuracy		V _{MAXV} = V _{REF} x 0.67, V _{OS1} to V _{OS2} = \pm 4V, V _{DD} = 5V	-2		+2	%
		V _{MAXV} = V _{REF} x 0.33, V _{OS1} to V _{OS2} = \pm 2V, V _{DD} = 3V	-2		+2	%
MAXV, MAXIP, MAXIN Input Bias Current	I _{MAXV-BIAS} , I _{MAXI_-BIAS}	V _{MAXV} = V _{MAXI_} = 0.1V or 1.5V	-0.1		+0.1	μ A
CTLI Gain Accuracy	A _{CTLI}	V _{CTLI} = 0.5V to 2.5V (Note 3)	9.5	10	10.5	V/V
CTLI Input Resistance	R _{CTLI}	1M Ω terminated at REF	0.5	1.0	2.0	M Ω
Error-Amp Transconductance	g _m		50	100	175	μ A/V
ITEC Accuracy		V _{OS1} to V _{CS} = +100mV or -100mV	-10		+10	%
ITEC Load Regulation	Δ V _{ITEC}	V _{OS1} to V _{CS} = +100mV or -100mV, I _{ITEC} = \pm 10 μ A	-0.1		+0.1	%

Power Drivers for Peltier TEC Modules

MAX1968/MAX1969

ELECTRICAL CHARACTERISTICS

(V_{DD} = PV_{DD1} = PV_{DD2} = $\overline{\text{SHDN}}$ = 5V, PGND1 = PGND2 = FREQ = GND, CT_{LI} = MAXV = MAXIP = MAXIN = REF, C_{REF} = 1μF, C_{COMP} = 0.1μF, L_{LLX} = 3.3μH, C_{CS} = C_{OS2} = 1μF, I_{TEC} < 3A _{RMS} (MAX1968), I_{TEC} < 6A _{RMS} (MAX1969), T_A = -40°C to +85°C, unless otherwise noted.) (Note 4)

PARAMETER	SYMBOL	CONDITIONS	MIN	TYP	MAX	UNITS	
Input Supply Range	V _{DD}		3.0		5.5	V	
Output Voltage Range	V _{OUT}	V _{DD} = 5V, I _{TEC} = 0 to ±3A, V _{OUT} = V _{OS1} - V _{OS2} (MAX1968)	-4.3		+4.3	V	
		V _{DD} = 5V, I _{TEC} = 0 to 6A, V _{OUT} = V _{OS1} (MAX1969)			4.3		
		V _{DD} = 3V, I _{TEC} = 0 to ±3A, V _{OUT} = V _{OS1} - V _{OS2} (MAX1968)	-2.3		+2.3		
		V _{DD} = 3V, I _{TEC} = 0 to 6A, V _{OUT} = V _{OS1} (MAX1969)			2.3		
Maximum TEC Current	I _{TEC(MAX)}	MAX1968			±3	A	
		MAX1969			6		
Reference Voltage	V _{REF}	V _{DD} = 3V to 5.5V, I _{REF} = 150μA	1.475		1.515	V	
Reference Load Regulation	ΔV _{REF}	V _{DD} = 3V to 5.5V, I _{REF} = +10μA to -1mA			5	mV	
Current-Sense Threshold Accuracy		V _{OS1} < V _{CS}	V _{MAXI_L} = V _{REF}	135		165	mV
			V _{MAXI_L} = V _{REF} / 3	35		65	
		V _{OS1} > V _{CS}	V _{MAXI_L} = V _{REF}	135		165	
			V _{MAXI_L} = V _{REF} / 3	35		65	
Switch-Fault Reset Voltage			50		250	mV	
NFET On-Resistance	R _{DS(ON-N)}	V _{DD} = 5V, I = 0.5A			0.07	Ω	
		V _{DD} = 3V, I = 0.5A			0.08		
PFET On-Resistance	R _{DS(ON-P)}	V _{DD} = 5V, I = 0.5A			0.07	Ω	
		V _{DD} = 3V, I = 0.5A			0.12		
NFET Leakage	I _{LEAK(N)}	V _{LX} = V _{DD} = 5V, T _A = +25°C			10	μA	
		V _{LX} = V _{DD} = 5V, T _A = -40°C			10		
PFET Leakage	I _{LEAK(P)}	V _{LX} = 0, T _A = +25°C			10	μA	
		V _{LX} = 0, T _A = -40°C			10		
No Load Supply Current	I _{DD(NO LOAD)}	V _{DD} = 5V			100	mA	
		V _{DD} = 3.3V			30		
Shutdown Supply Current	I _{DD-SD}	$\overline{\text{SHDN}}$ = GND, V _{DD} = 5V (Note 2)			3	mA	
UVLO Threshold	V _{UVLO}	V _{DD} rising	2.4		2.8	V	
		V _{DD} falling	2.25		2.75		
Switching-Frequency Internal Oscillator	f _{SW-INT}	FREQ = GND	400		650	kHz	

Power Drivers for Peltier TEC Modules

MAX1968/MAX1969

ELECTRICAL CHARACTERISTICS (continued)

(V_{DD} = PV_{DD1} = PV_{DD2} = $\overline{\text{SHDN}}$ = 5V, PGND1 = PGND2 = FREQ = GND, CT_{LI} = MAXV = MAXIP = MAXIN = REF, C_{REF} = 1μF, C_{COMP} = 0.01μF, L_{LX_} = 3.3μH, C_{CS} = C_{OS2} = 1μF, I_{TEC} < 3A_{RMS} (MAX1968), I_{TEC} < 6A_{RMS} (MAX1969), T_A = -40°C to +85°C, unless otherwise noted.) (Note 4)

PARAMETER	SYMBOL	CONDITIONS	MIN	TYP	MAX	UNITS
OS1, OS2, CS Input Current	I _{OS1} , I _{OS2} , I _{CS}	0 or V _{DD}	-100		+100	μA
$\overline{\text{SHDN}}$, FREQ Input Current	I $\overline{\text{SHDN}}$, I _{FREQ}	0 or V _{DD}	-5		+5	μA
$\overline{\text{SHDN}}$, FREQ Input Low Voltage	V _{IL}	V _{DD} = 3V to 5.5V			V _{DD} × 0.25	V
$\overline{\text{SHDN}}$, FREQ Input High Voltage	V _{IH}	V _{DD} = 3V to 5.5V	V _{DD} × 0.75			
MAXV Threshold Accuracy		V _{MAXV} = V _{REF} × 0.67, V _{OS1} to V _{OS2} = ±4V, V _{DD} = 5V	-2		+2	%
		V _{MAXV} = V _{REF} × 0.33, V _{OS1} to V _{OS2} = ±2V, V _{DD} = 3V				
MAXV, MAXIP, MAXIN Input Bias Current	I _{MAXV-BIAS} , I _{MAXI_-BIAS}	V _{MAXV} = V _{MAXI_} = 0.1V or 1.5V	-0.1		+0.1	μA
CTLI Gain Accuracy	A _{CTLI}	V _{CTLI} = 0.5V to 2.5V (Note 3)	9.5		10.5	V/V
CTLI Input Resistance	R _{CTLI}	1MΩ terminated at REF	0.5		2.0	MΩ
Error-Amp Transconductance	g _m		50		175	μA/V
ITEC Accuracy		V _{OS1} to V _{CS} = +100mV or -100mV	-10		+10	%

Note 2: Includes power FET leakage.

Note 3: CT_{LI} Gain is defined as:

$$A_{CTLI} = \frac{(V_{CTLI} - V_{REF})}{V_{OS1} - V_{CS}}$$

Note 4: Specifications to -40°C are guaranteed by design, not production tested.

Power Drivers for Peltier TEC Modules

Typical Operating Characteristics

($V_{DD} = 5V$, $V_{CTLI} = 1V$, $V_{FREQ} = GND$, $R_{LOAD} = 1\Omega$, circuit of Figure 1, $T_A = +25^\circ C$, unless otherwise noted.)

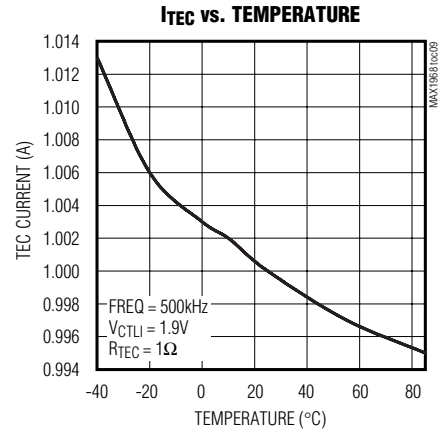
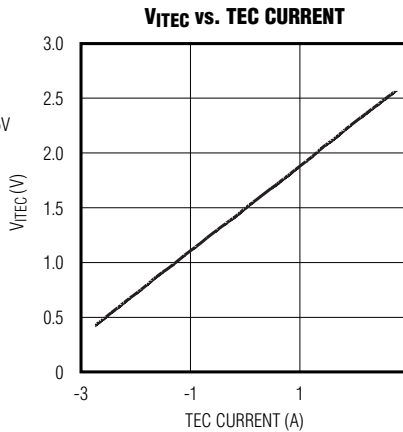
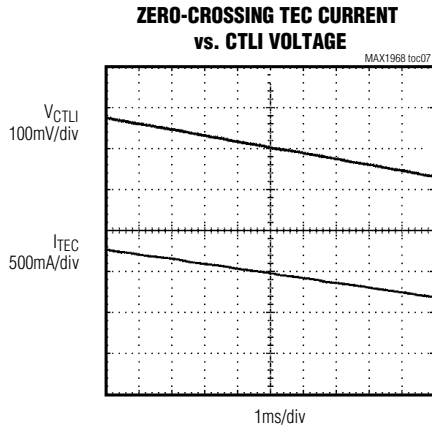
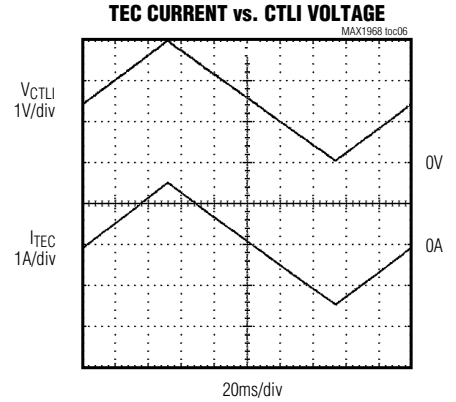
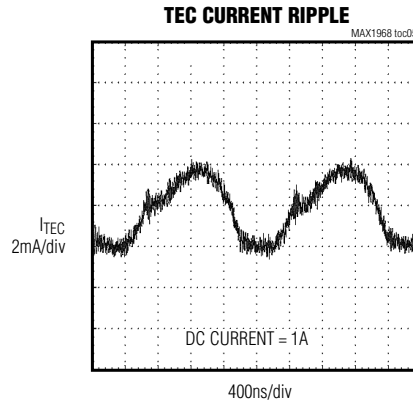
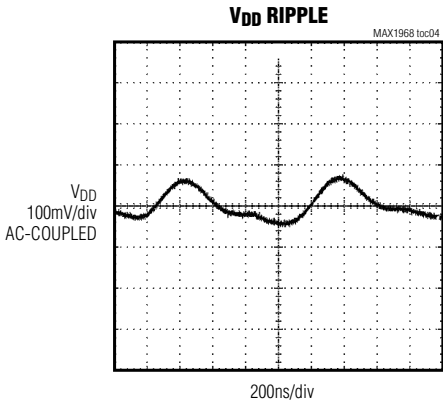
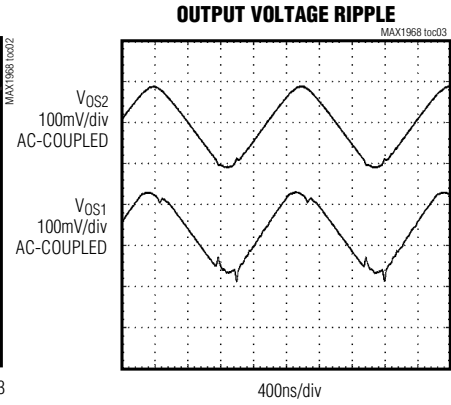
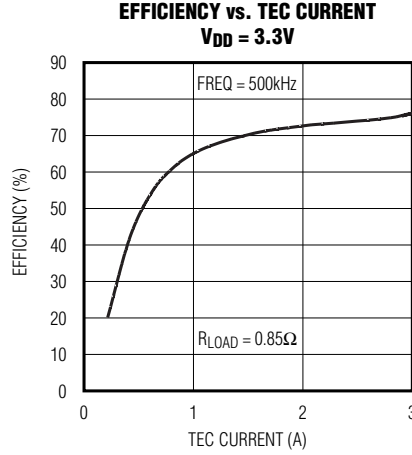
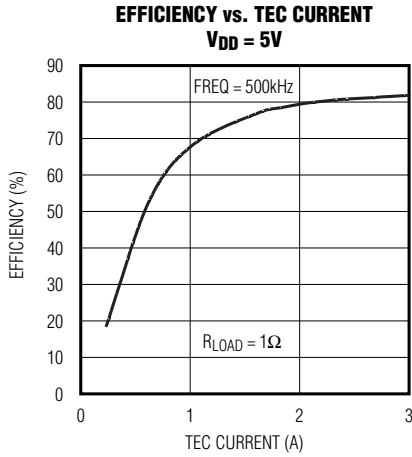

Power Drivers for Peltier TEC Modules

MAX1968/MAX1969

Typical Operating Characteristics (continued)

($V_{DD} = 5V$, $V_{CTLI} = 1V$, $V_{FREQ} = GND$, $R_{LOAD} = 1\Omega$, circuit of Figure 1, $T_A = +25^\circ C$, unless otherwise noted.)

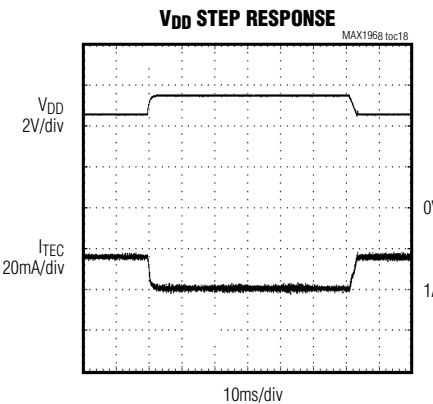
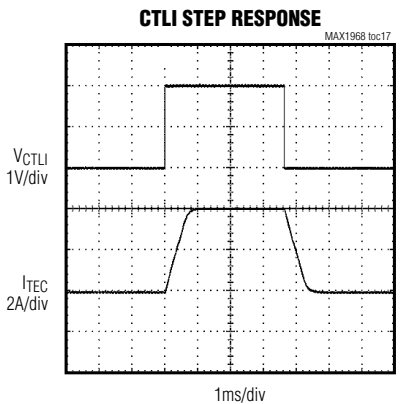
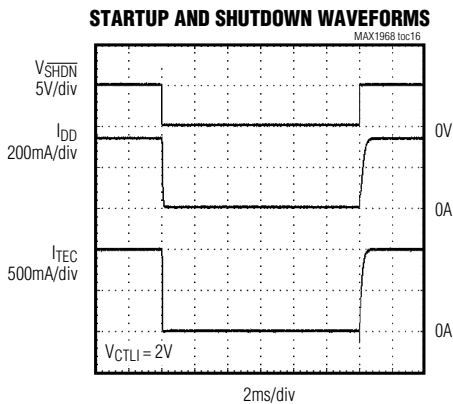
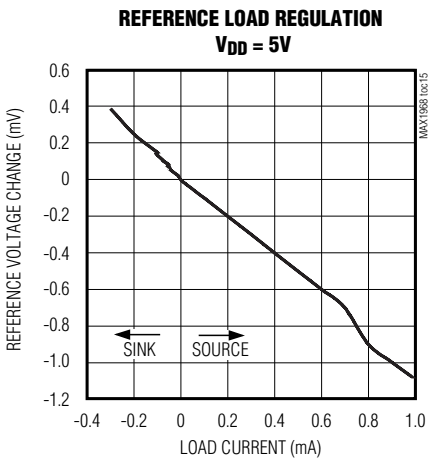
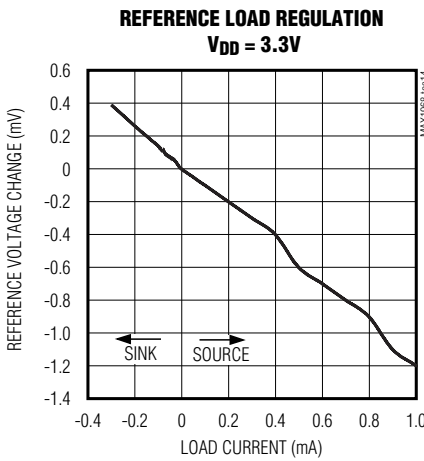
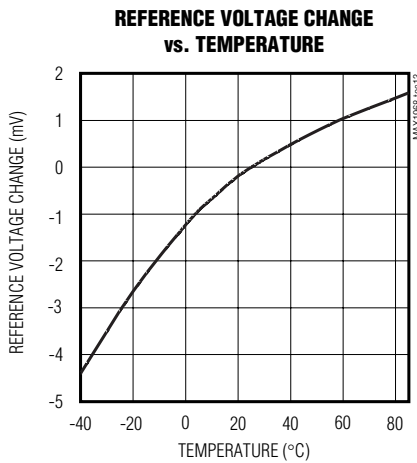
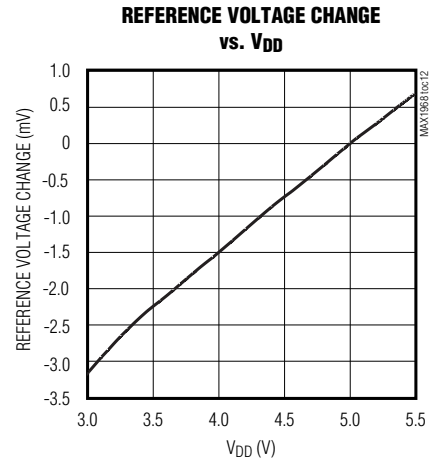
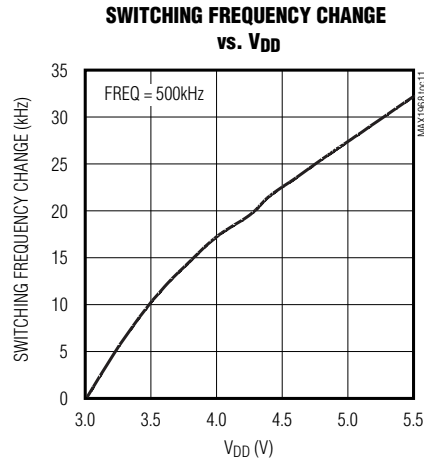
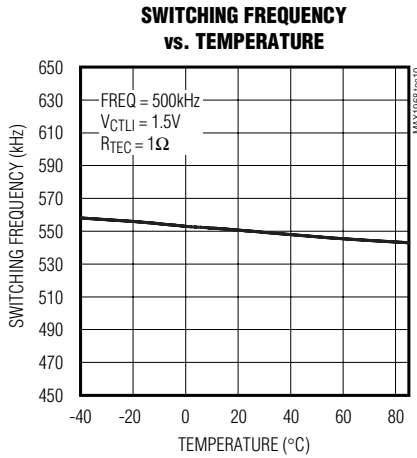

Power Drivers for Peltier TEC Modules

Typical Operating Characteristics (continued)

(V_{DD} = 5V, V_{CTLI} = 1V, V_{FREQ} = GND, R_{LOAD} = 1Ω, circuit of Figure 1, T_A = +25°C, unless otherwise noted.)

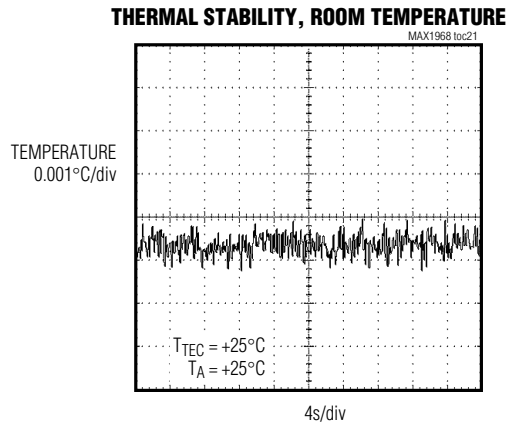
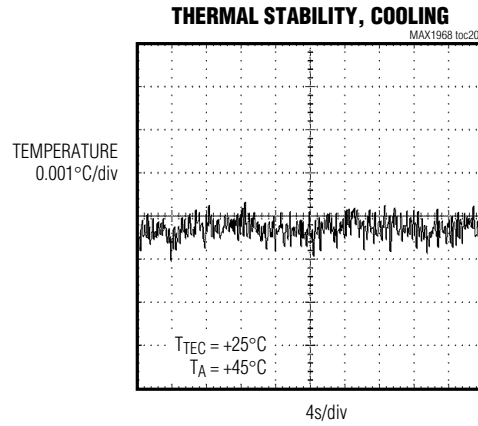
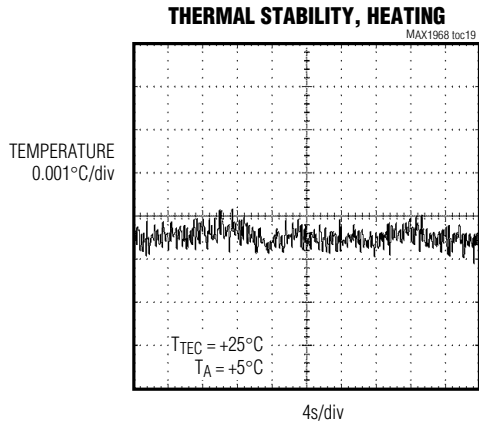

Power Drivers for Peltier TEC Modules

Pin Description

PIN	NAME	FUNCTION
1	V _{DD}	Analog Supply Voltage Input
2	GND	Analog Ground. Connect to underside metal slug.
3	CTLI	TEC Current Control Input. Sets differential current into the TEC. Center point is 1.50V (no TEC current). The current is given by: $I_{TEC} = (V_{OS1} - V_{CS}) / R_{SENSE} = (V_{CTLI} - 1.50) / (10 \times R_{SENSE})$. When $(V_{CTLI} - V_{REF}) > 0$, $V_{OS2} > V_{OS1} > V_{CS}$.
4	REF	1.50V Reference Output. Bypass REF to GND with a 1 μ F ceramic capacitor.
5, 7	PGND2	Power Ground 2. Internal synchronous rectifier ground connections. Connect all PGND pins together at power ground plane.
6, 8, 10	LX2	Inductor Connection. Connect all LX2 pins together. For MAX1969, connect LX1 and LX2 pins together.
9, 11	PV _{DD2}	Power 2 Inputs. Must be same voltage as V _{DD} . Connect all PV _{DD2} inputs together at the V _{DD} power plane.
12	FREQ	Switching Frequency Select. High = 1MHz, Low = 500kHz.
13	ITEC	TEC Current Monitor Output. The ITEC output voltage is a function of the voltage across the TEC current-sense resistor. $V_{ITEC} = 1.50V + (V_{OS1} - V_{CS}) \times 8$.
14	OS2	Output Sense 2. OS2 senses one side of the differential TEC voltage. OS2 is a sense point, not a power output. For MAX1969, connect OS2 to GND.
15	OS1	Output Sense 1. OS1 senses one side of the differential TEC voltage. OS1 is a sense point, not a power output.
16	CS	Current-Sense Input. The current through the TEC is monitored between CS and OS1. The maximum TEC current is given by $150mV / R_{SENSE}$ and is bipolar.
17	SHDN	Shutdown Control Input. Active-low shutdown control.
18, 20	PV _{DD1}	Power 1 Inputs. Must be same voltage as V _{DD} . Connect all PV _{DD1} inputs together at the V _{DD} power plane.
19, 21, 23	LX1	Inductor Connection. Connect all LX1 pins together. For MAX1969, connect all LX1 and LX2 pins together.
22, 24	PGND1	Power Ground 1. Internal synchronous rectifier ground connections. Connect all PGND pins together at power ground plane.
25	COMP	Current Control-Loop Compensation. For most designs connect a 0.01 μ F capacitor from COMP to GND.
26	MAXIN	Maximum Negative TEC Current. Connect MAXIN to REF to set default negative current limit $-150mV / R_{SENSE}$. For MAX1969, connect MAXIN to GND.
27	MAXIP	Maximum Positive TEC Current. Connect MAXIP to REF to set default positive current limit $+150mV / R_{SENSE}$.
28	MAXV	Maximum Bipolar TEC Voltage. Connect an external resistive-divider from REF to GND to set the maximum voltage. The maximum TEC voltage is $4 \times V_{MAXV}$.

MAX1968/MAX1969

Power Drivers for Peltier TEC Modules

MAX1968/MAX1969

Functional Diagram

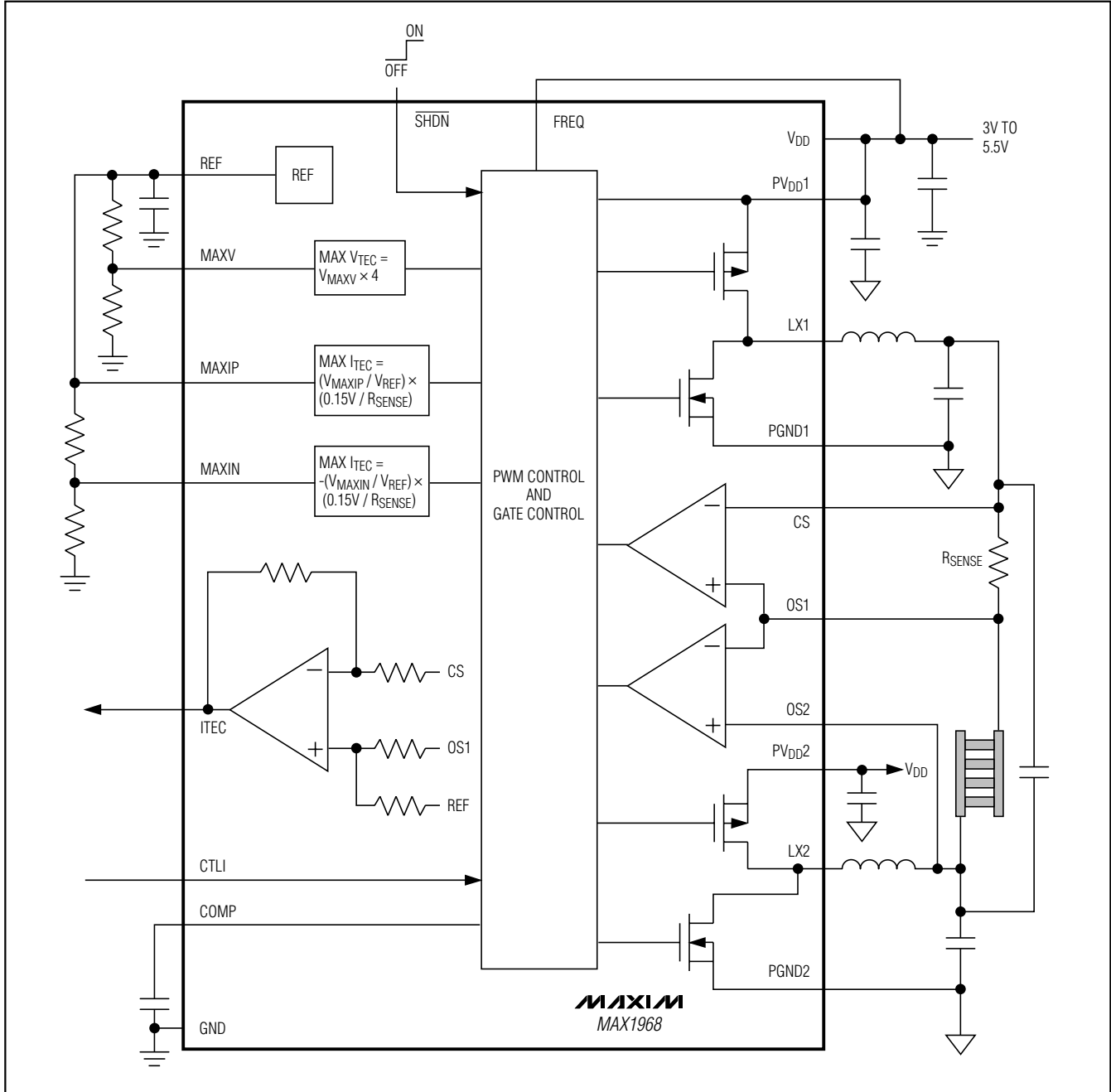

Power Drivers for Peltier TEC Modules

Detailed Description

The MAX1968/MAX1969 TEC drivers consist of two switching buck regulators that operate together to directly control TEC current. This configuration creates a differential voltage across the TEC, allowing bidirectional TEC current for controlled cooling and heating. Controlled cooling and heating allow accurate TEC temperature control within the tight tolerances of laser driver specifications. The voltage at CTLI directly sets the TEC current. An external thermal-control loop is typically used to drive CTLI. Figures 1 and 2 show examples of thermal control-loop circuits.

Ripple Cancellation

Switching regulators like those used in the MAX1968/MAX1969 inherently create ripple voltage on the output. The regulators in the MAX1968 switch in phase and provide complementary in-phase duty cycles so ripple waveforms at the TEC are greatly reduced. This feature suppresses ripple currents and electrical noise at the TEC to prevent interference with the laser diode.

Switching Frequency

FREQ sets the switching frequency of the internal oscillator. With FREQ = GND, the oscillator frequency is set to 500kHz. The oscillator frequency is 1MHz when FREQ = VDD.

Voltage and Current-Limit Settings

Both the MAX1968 and MAX1969 provide control of the maximum differential TEC voltage. Applying a voltage to MAXV limits the maximum voltage across the TEC. The MAX1968 provides control of the maximum positive and negative TEC current. The voltage at MAXIP and MAXIN sets the maximum positive and negative current through the TEC. These current limits can be independently controlled. The MAX1969 only controls TEC current in one direction. The maximum TEC current is controlled by MAXIP. Connect MAXIN to GND when using the MAX1969.

Current Monitor Output

ITEC provides a voltage output proportional to the TEC current (ITEC). See the *Functional Diagram* for more detail:

$$V_{ITEC} = 1.5V + 8 \times (V_{OS1} - V_{CS})$$

Reference Output

The MAX1968/MAX1969 include an on-chip voltage reference. The 1.50V reference is accurate to 1% over temperature. Bypass REF with 1μF to GND. REF may be used to bias an external thermistor for temperature sensing as shown in Figures 1 and 2.

Design Procedure

Inductor Selection

Small surface-mount inductors are ideal for use with the MAX1968/MAX1969. 3.3μH inductors are suitable for most applications. Select the output inductors so that the LC resonant frequency of the inductance and the output capacitance is less than 1/5 the selected switching frequency. For example, 3.3μH and 1μF have a resonance at 87.6kHz, which is adequate for 500kHz operation

$$f = \frac{1}{2\pi\sqrt{LC}}$$

where:

f = resonant frequency of output filter.

Capacitor Selection

Filter Capacitors

Decouple each power-supply input (VDD, PVDD1, PVDD2) with a 1μF ceramic capacitor close to the supply pins. In some applications with long distances between the source supply and the MAX1968/MAX1969, additional bypassing may be needed to stabilize the input supply. In such cases, a low-ESR electrolytic capacitor of 100μF or more at VDD is usually sufficient.

Compensation Capacitor

A compensation capacitor is needed to ensure current control-loop stability. Select the capacitor so that the unity-gain bandwidth of the current control loop is less than or equal to 1/12th the resonant frequency of the output filter:

$$C_{COMP} \geq \left(\frac{g_m}{f}\right) \times \left(\frac{R_{TEC}}{2\pi \times R_{SENSE}}\right)$$

where:

f = loop frequency, less than or equal to the output filter resonant frequency

g_m = loop transconductance, typically 100μA/V

C_{COMP} = value of the compensation capacitor

R_{TEC} = TEC series resistance

R_{SENSE} = sense resistor

Setting Voltage and Current Limits

Certain TEC parameters must be considered to guarantee a robust design. These include maximum positive current, maximum negative current, and the maximum voltage allowed across the TEC. These limits should be used to set the MAXIP, MAXIN, and MAXV voltages.

Power Drivers for Peltier TEC Modules

Setting Max Positive and Negative TEC Current

MAXIP and MAXIN set the maximum positive and negative TEC currents, respectively. The default current limit is $\pm 150\text{mV} / R_{\text{SENSE}}$ when MAXIP and MAXIN are connected to REF. To set maximum limits other than the defaults, connect a resistor-divider from REF to GND to set V_{MAXI_-} . Use resistors in the $10\text{k}\Omega$ to $100\text{k}\Omega$ range. V_{MAXI_-} is related to I_{TEC} by the following equations:

$$V_{\text{MAXIP}} = 10(I_{\text{TECP}(\text{MAX})} \times R_{\text{SENSE}})$$

$$V_{\text{MAXIN}} = 10(I_{\text{TECN}(\text{MAX})} \times R_{\text{SENSE}})$$

where $I_{\text{TECP}(\text{MAX})}$ is the maximum positive TEC current and $I_{\text{TECN}(\text{MAX})}$ is the negative maximum TEC current.

Positive TEC current occurs when CS is less than OS1:

$$I_{\text{TEC}} \times R_{\text{SENSE}} = \text{CS} - \text{OS1}$$

when $I_{\text{TEC}} < 0$.

$$I_{\text{TEC}} \times R_{\text{SENSE}} = \text{OS1} - \text{CS}$$

when $I_{\text{TEC}} > 0$.

The MAX1969 controls the TEC current in one direction (unipolar). Set the maximum unipolar TEC current by applying a voltage to MAXIP. Connect MAXIN to GND. The equation for setting MAXIP is the same for the MAX1968 and MAX1969.

Take care not to exceed the positive or negative current limit on the TEC. Refer to the manufacturer's data sheet for these limits.

Setting MAX TEC Voltage

Apply a voltage to the MAXV pin to control the maximum differential TEC voltage. MAXV can vary from 0 to REF. The voltage across the TEC is four times V_{MAXV} and can be positive or negative:

$$|V_{\text{OS1}} - V_{\text{OS2}}| = 4 \times V_{\text{MAXV}}$$

Set V_{MAXV} with a resistor-divider between REF and GND using resistors from $10\text{k}\Omega$ to $100\text{k}\Omega$. V_{MAXV} can vary from 0 to REF.

Control Inputs/Outputs

Output Current Control

The voltage at CTLI directly sets the TEC current. CTLI is typically driven from the output of a temperature control loop. For the purposes of the following equations, it is assumed that positive TEC current is heating. The transfer function relating current through the TEC (I_{TEC}) and V_{CTLI} is given by:

$$I_{\text{TEC}} = (V_{\text{CTLI}} - V_{\text{REF}}) / (10 \times R_{\text{SENSE}})$$

where V_{REF} is 1.50V and:

$$I_{\text{TEC}} = (V_{\text{OS1}} - V_{\text{CS}}) / R_{\text{SENSE}}$$

CTLI is centered around REF (1.50V). I_{TEC} is zero when $V_{\text{CTLI}} = 1.50\text{V}$. When $V_{\text{CTLI}} > 1.50\text{V}$ the MAX1968 is heating. Current flow is from OS2 to OS1. The voltages on the pins relate as follows:

$$V_{\text{OS2}} > V_{\text{OS1}} > V_{\text{CS}}$$

The opposite applies when cooling. When $V_{\text{CTLI}} < 1.50\text{V}$ current flows from OS1 to OS2:

$$V_{\text{OS2}} < V_{\text{OS1}} < V_{\text{CS}}$$

Shutdown Control

The MAX1968/MAX1969 can be placed in a power-saving shutdown mode by driving $\overline{\text{SHDN}}$ low. When the MAX1968/MAX1969 are shut down, the TEC is off (OS1 and OS2 decay to GND) and supply current is reduced to 2mA (typ).

ITEC Output

ITEC is a status output that provides a voltage proportional to the actual TEC current. $I_{\text{TEC}} = \text{REF}$ when TEC current is zero. The transfer function for the ITEC output is:

$$V_{\text{ITEC}} = 1.50 + 8 \times (V_{\text{OS1}} - V_{\text{CS}})$$

Use ITEC to monitor the cooling or heating current through the TEC. The maximum capacitance that ITEC can drive is 100pF.

Power Drivers for Peltier TEC Modules

MAX1968/MAX1969

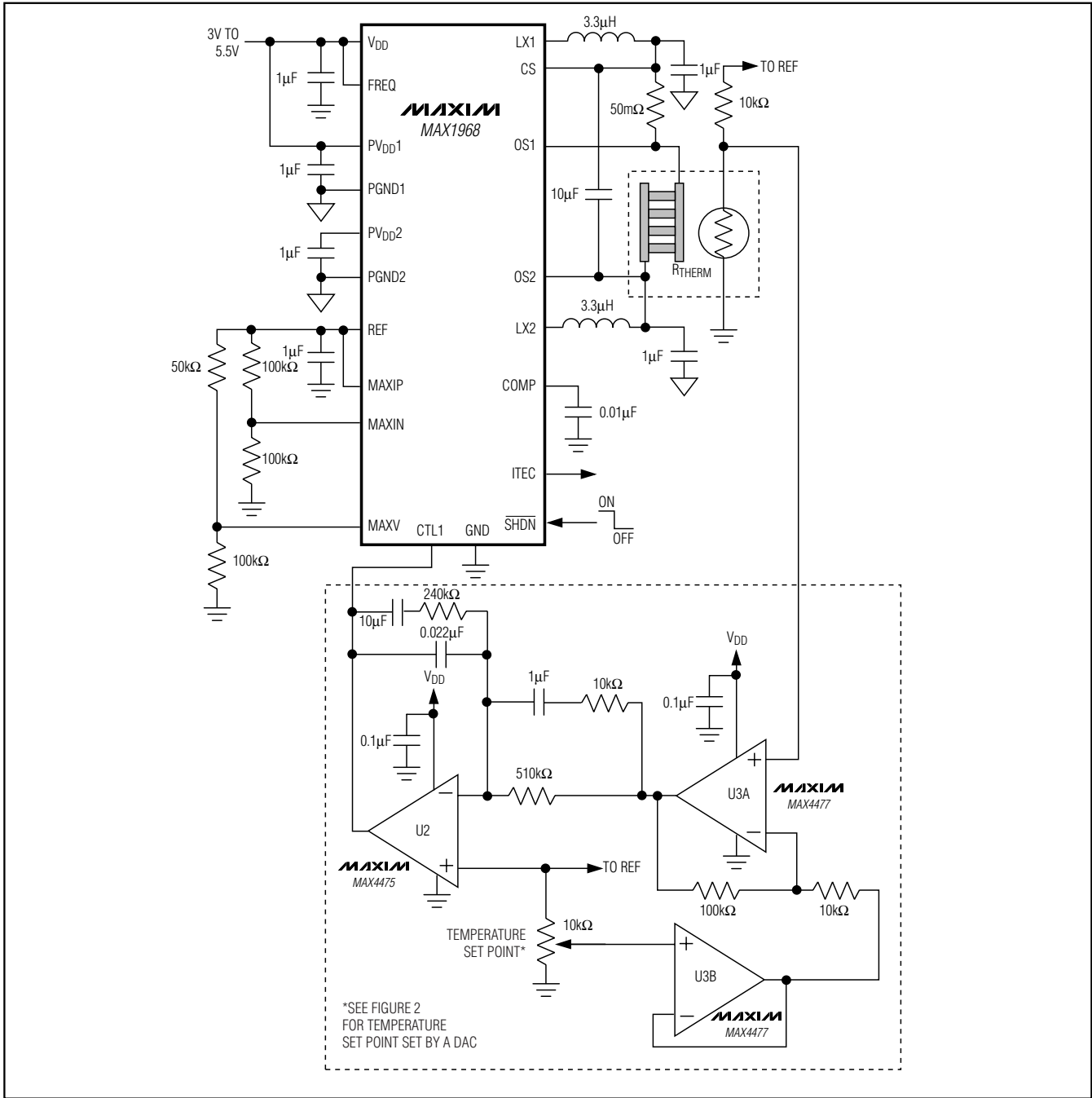

Figure 1. Typical Application Circuit for MAX1968

Power Drivers for Peltier TEC Modules

Applications Information

The MAX1968/MAX1969 typically drive a thermoelectric cooler inside a thermal control loop. TEC drive polarity and power are regulated based on temperature information read from a thermistor, or other temperature-measuring device to maintain a stable control temperature. Temperature stability of 0.01°C can be achieved with carefully selected external components.

There are numerous ways to implement the thermal loop. Figures 1 and 2 show a design that employs precision op amps, along with a DAC or potentiometer to set the control temperature. The loop may also be implemented digitally, using a precision A/D to read the thermistor or other temperature sensor, a microcontroller to implement the control algorithm, and a DAC (or filtered PWM signal) to send the appropriate signal to the MAX1968/MAX1969 CTLI input. Regardless of the form taken by the thermal control circuitry, all designs are similar in that they read temperature, compare it to a set-point signal, and then send an error-correcting signal to the MAX1968/MAX1969 that moves the temperature in the appropriate direction.

Chip Information

TRANSISTOR COUNT: 2959

PROCESS: BiCMOS

MAX1968/MAX1969

Pin Configuration

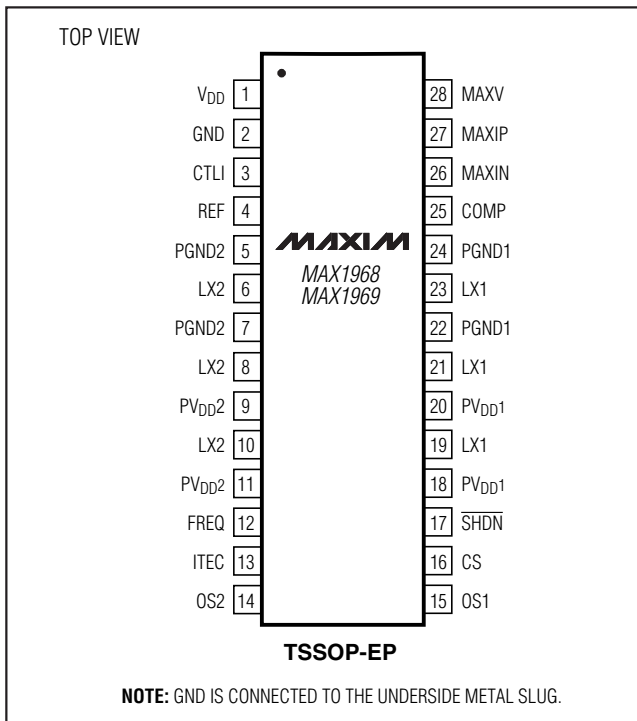

Power Drivers for Peltier TEC Modules

Package Information

(The package drawing(s) in this data sheet may not reflect the most current specifications. For the latest package outline information, go to www.maxim-ic.com/packages.)

Symbol	COMMON DIMENSIONS			
	MILLIMETERS		INCHES	
	MIN.	MAX.	MIN.	MAX.
A	—	1.10	—	.043
A ₁	0.05	0.15	.002	.006
A ₂	0.85	0.95	.033	.037
b	0.19	0.30	.007	.012
b ₁	0.19	0.25	.007	.010
c	0.090	0.20	.0035	.008
c ₁	0.090	0.135	.0035	.0053
D	SEE VARIATIONS		SEE VARIATIONS	
E	4.30	4.50	.169	.177
e	0.65 BSC		.026 BSC	
H	6.25	6.50	.246	.256
L	0.50	0.70	.020	.028
N	SEE VARIATIONS		SEE VARIATIONS	
Y	2.85	3.15	.112	.124
α	0°	8°	0°	8°

JEDEC	Symbol	VARIATIONS			
		MILLIMETERS		INCHES	
		MIN.	MAX.	MIN.	MAX.
MD-153	N				
AC	D	4.90	5.10	.193	.201
	X	2.85	3.15	.112	.124
AD	D	6.40	6.60	.252	.260
	X	4.00	4.34	.157	.171
AF	D	9.60	9.80	.378	.386
	X	5.35	5.65	.211	.222

NOTES:

- DIMENSIONS D AND E DO NOT INCLUDE FLASH
- MOLD FLASH OR PROTRUSIONS NOT TO EXCEED 0.15mm PER SIDE
- CONTROLLING DIMENSION: MILLIMETER
- MEETS JEDEC OUTLINE MD-153 VARIATIONS- AC, AD, AF
- "N" REFERS TO NUMBER OF LEADS
- EXPOSED PAD FLUSH WITH BOTTOM OF PACKAGE WITHIN .002"

THE LEAD TIPS MUST LIE WITHIN A SPECIFIED ZONE. THIS TOLERANCE ZONE IS DEFINED BY TWO PARALLEL PLANES. ONE PLANE IS THE SEATING PLANE, DATUM [-C-]; THE OTHER PLANE IS AT THE SPECIFIED DISTANCE FROM [-C-] IN THE DIRECTION INDICATED.

MAXIM

PROPRIETARY INFORMATION

TITLE
PACKAGE OUTLINE, TSSOP, 4.40 MM BODY, EXPOSED PAD

APPROVAL	DOCUMENT CONTROL NO. 21-0108	REV A	1/1
----------	---------------------------------	----------	-----

TSSOP, 4.0 EXP PADS, EPS

Maxim cannot assume responsibility for use of any circuitry other than circuitry entirely embodied in a Maxim product. No circuit patent licenses are implied. Maxim reserves the right to change the circuitry and specifications without notice at any time.